

---

# Table of Contents

## E65 Windshield Wiping and Washing

Subject	Page
<b>Introduction</b> .....	<b>4</b>
<b>System Overview</b> .....	<b>5</b>
Components .....	5
Wiper Drive Unit .....	6
Wiper Switch (SWS) .....	7
Vehicle Bus System Interfaces .....	8
Steering Column Switch Center (SZL) .....	8
Safety Information Module (SIM) .....	8
Central Gateway Module (ZGM) .....	8
Light Module (LM) .....	9
Car Access System (CAS) .....	9
Power Module (PM) .....	9
Instrument Cluster (Kombi) .....	9
Control Display (CD) .....	9
Dynamic Stability Control (DSC) .....	9
Rain/Light Sensor (RLS) .....	9
Wet-Arm Heater (NAH) .....	11
<b>Principle of Operation</b> .....	<b>12</b>
Wiper Position .....	13
Regulated Wiper Speed .....	13
Reverse Wiper Control .....	13
Wiper Stages 1 and 2 .....	14
Rain Sensor Operation .....	14
Single Wipe .....	15
Alternating Park Position (APS) .....	15
Windshield Washer System (SWA) .....	16
Wet-Arm Heater (NAH) .....	17
Headlight Cleaning System (SRA) .....	17
Snow Mode .....	18
Blocking Protection .....	18
Sluggish Mode .....	19

---

<b>Subject</b>	<b>Page</b>
<b>Workshop Hints</b> .....	<b>19</b>
Service Position .....	19
Washer Jet Cleaning Function .....	20
Check Control Messages .....	20
Diagnosis .....	21
Default Values .....	22
Assembly position for the replacement of the wiper drive unit .....	22

---

# E65 Windshield Wiping and Washing

**Vehicle: E65/E66**

**Production: All**

## OBJECTIVES

After completion of this module you will be able to:

- Identify and locate windshield wiper components
- Understand E65 windshield wiper systems

---

## Introduction

To meet the rising expectations of customers in the future, the wiper system was redeveloped to achieve the following design goals:

- User-friendly
- Quiet
- Low operating costs

For the first time, the windshield wiper uses an electronically reversible wiper control (like the rear window wiper of the E39/E53). The reversing gear and the relay are no longer needed.

The main advantages compared with previous conventional wiper systems are:

- Improved accuracy of wiping angle in the reversing direction.
- Reduced wiper noise.
- Wiper arm speed is dependent on the wiper arm position on the windshield.
- Less space is required for the wiper linkage because the motor rotation is limited to 180°.
- The wiper system adapts to snow load within the minimum field of view.
- The wiper arms have alternating park positions.

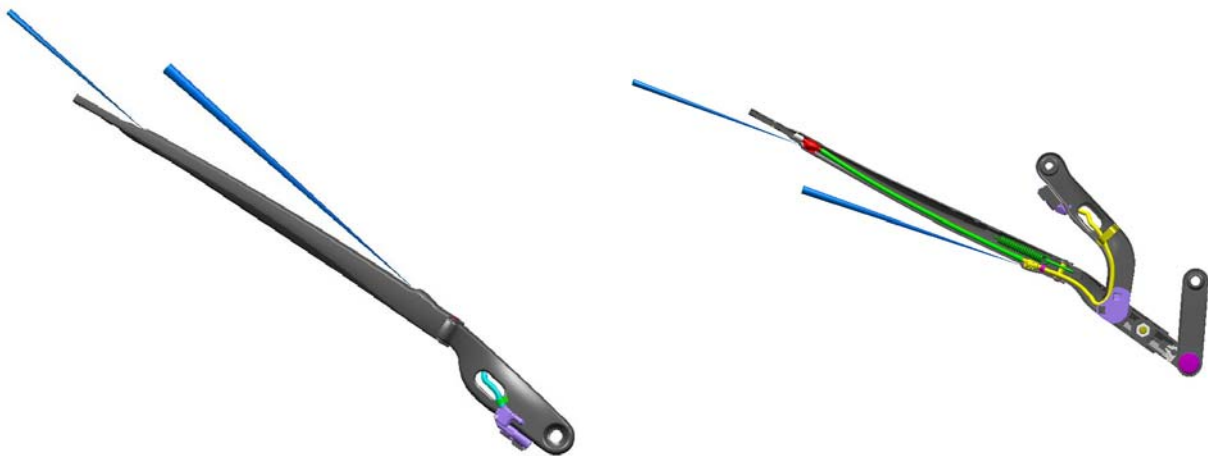

## System Overview

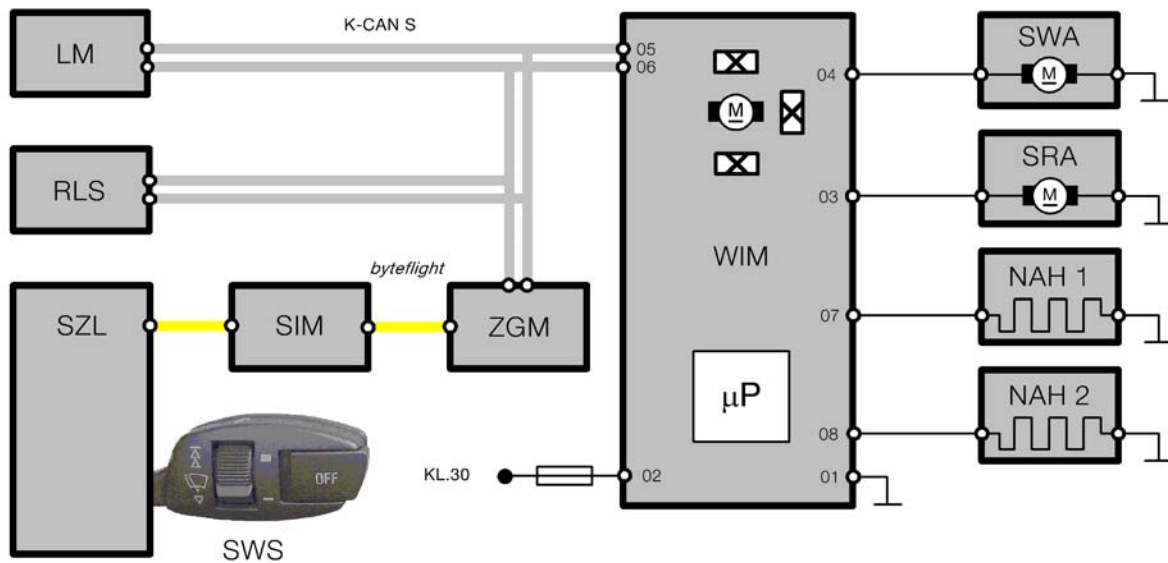

Index	Explanation	Index	Explanation
WIM	Wiper Module	SWS	Wiper Switch
RLS	Rain/Light Sensor	KL30	Terminal 30 (B+)
LM	Light Module	SWA	Windshield Washer System
SZL	Steering Column Switch Center	SRA	Headlight Washer System
SIM	Safety and Information Module	NAH 1	Wet-Arm Heater, left
ZGM	Central Gateway Module	NAH 2	Wet-Arm Heater, right
K-CAN S	K-CAN System	byteflight	Safety Bus for ISIS (fiber optic)

## Components

The components that make up the wiper system are:

- Wiper drive unit
- Wiper switch
- Vehicle bus system interface
- Rain/Light Sensor (RLS)
- Windshield and headlight washer system (pumps and tank)
- Wet-arm heater elements

---

## Wiper Drive Unit

The wiper system used in the E65 is designed as a two-arm/synchronization wiper system with an attached wiper drive. The wiper arms are guided by a swinging arm (crank with coupling link) on the driver's side and by a transverse link and a four-bar linkage on the front passenger's side.

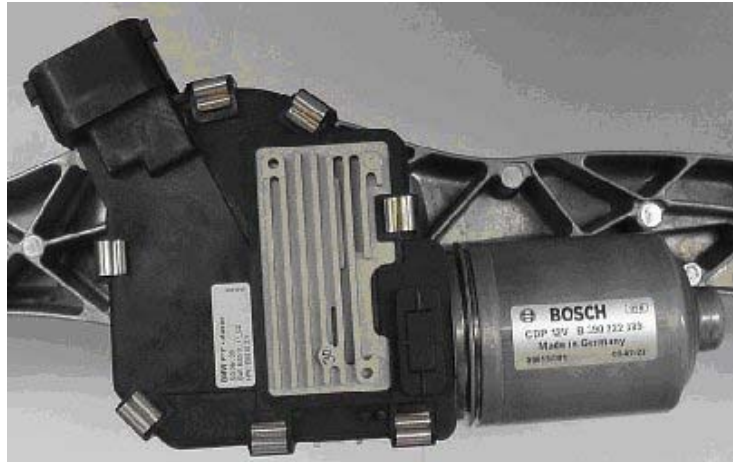

The wiper drive contains the following components:

- Reversible motor
- Reduction gear (worm gear)
- Gear case cover with integrated wiper module (WIM)

The wiper module is integrated in the wiper drive. The wiper module controls all wipe/wash functions.

The wiper module contains:

- Output stages for the wiper motor, washer pump and wet-arm heaters
- Position sensing by 3 Hall sensors
- K-CAN S interface
- Control unit

The position of the motor armature is detected by 3 hall sensors:

- 2 Hall sensors in connection with a ring magnet on the armature shaft.
- 1 Hall sensor and a magnetic disc on the gear wheel.

The two 2 Hall sensors on the armature shaft are installed in the wiper motor. The signals are used to determine:

- Wiper motor speed
- The direction of rotation of the wiper motor

---

The measurement is required for:

- Regulated wiper speed
- Snow mode detection
- Sluggish mode
- Lock up protection

A Hall sensor and a magnetic disc are mounted to the gear wheel of the wiper motor, they are used to determine the reference position of the wiper motor shaft.

The zero position can be reached when the reference position is determined.

- Zero position = park position.

**Note: The Hall sensor on the gear wheel replaces the previous mechanical park contact.**

### Wiper Switch (SWS)

The wiper switch is essentially an incremental switch, it does not lock into any positions. A “roll” mode is integrated in the operating concept. This allows one-touch control of wiper speed.

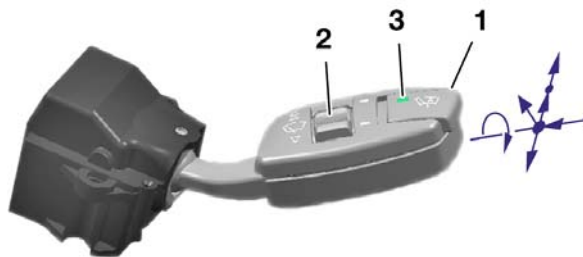

Roll mode: 1 tap up = stage 1

2 taps up = stage 2

From stage 2: 1 tap down = stage 1

2 taps down = off

3 taps down = single wipe

Pushing the wiper switch upwards past the detent activates stage 2.

A push button (1) used to turn the Rain/Light Sensor system on and off is on the end of the wiper switch. A four position thumb wheel (2) controls the sensitivity. The function status is indicated by LED (3).

A wash cycle is requested by pulling the stalk towards the driver.

The driver requests for the functions of the wiper system are signalled using Hall sensors inside the wiper switch. The sensor signals are interpreted by the Steering Column Switch Center (SZL).

## Vehicle Bus System Interfaces

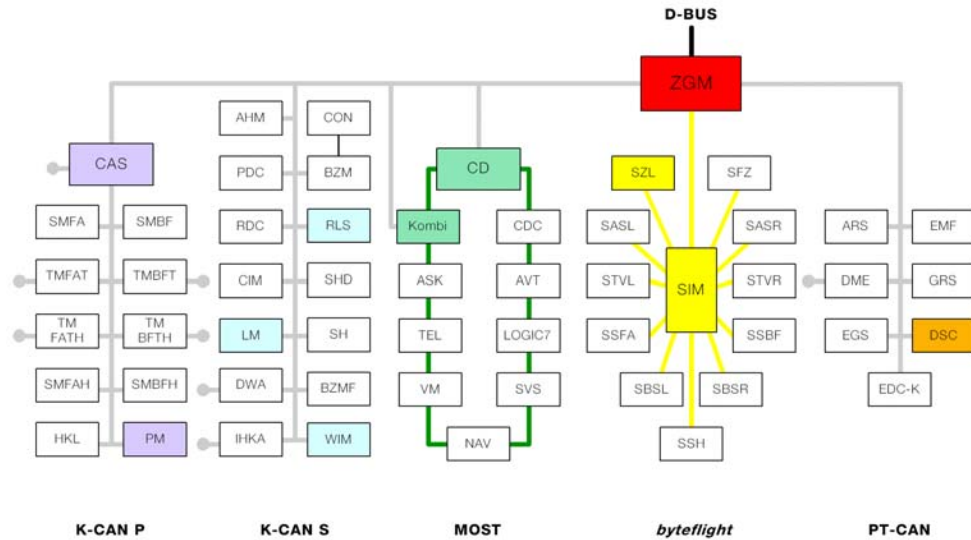

### Steering Column Switch Center (SZL)

The SZL evaluates the signal from the windshield wiper switch and calculates the wiper system function requested by the driver. The bus message is sent out on the byteflight.

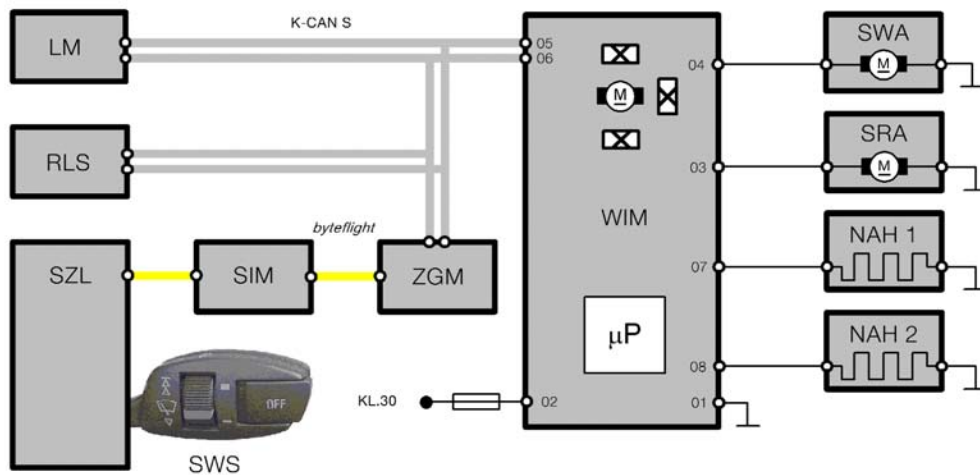

**Note: If communication between the wiper switch and the wiper module is disturbed, the failsafe result is continuous operation of the wipers.**

### Safety Information Module (SIM)

The SIM receives the driver's command from the SZL and relays it to the Central Gateway Module (ZGM) by byteflight.

### Central Gateway Module (ZGM)

As a gateway control unit, the ZGM receives the message from the SIM and relays the message to the Wiper Module via the K-CAN S.



## Light Module (LM)

The LM communicates to the wiper module when the parking lights are. This signal is used to enable the SRA (headlight cleaning system) function.

## Car Access System (CAS)

Terminal status is received from the CAS via the K-CAN S.

## Power Module (PM)

The System voltage is monitored by the Power module and communicated to all control units via the K-CAN P bus.

## Instrument Cluster (Kombi)

The instrument cluster provides the following information:

- Ambient temperature (wet-arm heater, defect code memory)
- Time (alternating park positions)
- Washer fluid level

The instrument cluster displays the Check Control messages: "wiper fault" or "refill washer fluid".

## Control Display (CD)

Extended Check Control messages are displayed by the Control Display.

## Dynamic Stability Control (DSC)

The DSC supplies the road-speed signal for the speed-dependent wiper functions.

## Rain/Light Sensor (RLS)

The Rain/Light Sensor is standard equipment, it is installed below the base of the rear view mirror as in other models.

The rain/driving light sensor in the E65 is an improved version of the first-generation rain sensor.

An additional driving light sensor is integrated into the rain/driving light sensor.

This function is described separately in the vehicle lighting chapter.

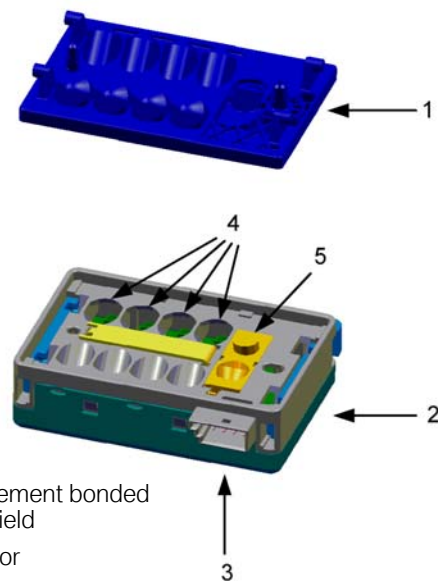

1. Optical element bonded to windshield
2. RLS sensor
3. Plug connection
4. Measurement diodes
5. light sensor

Modifications from the first-generation rain sensor:

- There are now 4 optical measurement sections instead of 2 which provides improved identification of dirt, salt etc.
- Integration of the light sensor function.
- K-CAN S interface
- Flash Programmable EEPROM.

The measuring principle of the RLS is identical to that of the previous rain sensor (AIC, automatic interval control).

The rain detection function is based on the principle of total reflection against the glass-to-air boundary surface:

- When the windshield is clean and dry, the infrared light transmitted by the rain/driving light sensor is fully reflected.
- When the windshield is wet or dirty in the area of the reflective surfaces, the conditions for total reflection no longer exist. As a result, less light is reflected.

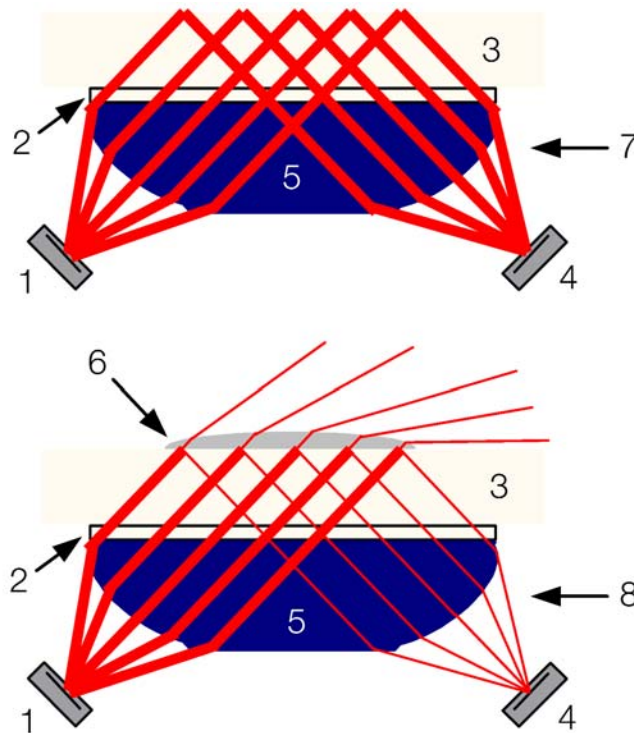

Index	Explanation	Index	Explanation
1	Transmitter	5	Optical element
2	Adhesive	6	Rain drop
3	Windshield	7	High intensity light
4	Receiver	8	Reduced intensity light

---

This change in the signal is evaluated by a microprocessor in the Rain/Light sensor (together with other signals, e.g. speed).

If necessary, a message is sent to the wiper module via the K-CAN S.

The wiper module then:

- Activates the wipe operation
- Determines the wiper speed and the interval duration

### **Wet-Arm Heater (NAH)**

The washer fluid in the washer fluid hose is heated electrically in the wiper arm.

There is a connector at the lower end of each wiper arm. The washer fluid hose is routed through this connector to the washer nozzle outlet at the end of the wiper arm.

A constant voltage wire, which is heated by the application of current, is integrated in the washer fluid hose. The constant voltage wire extends the full length of the washer fluid hose in the wiper arm.

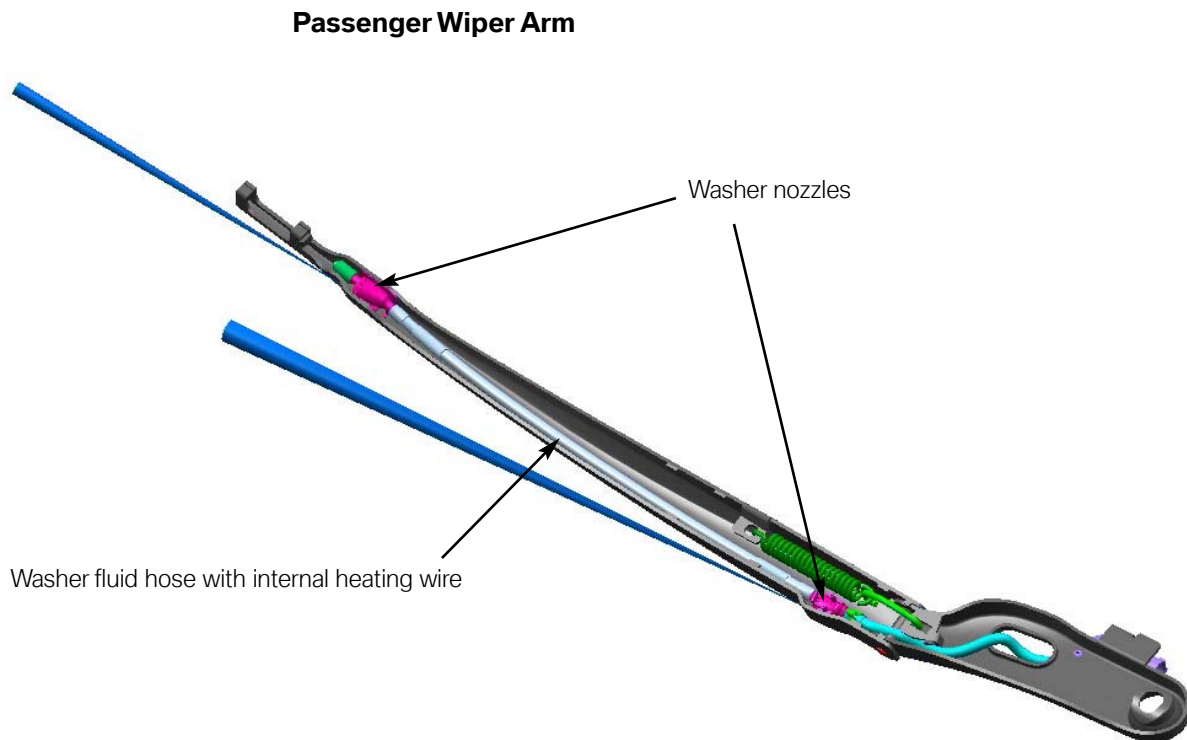

---

## Principle of Operation

In combination with the wiper switch and the Rain/Light Sensor, the wiper drive has the following functions:

- Regulated wiper speed
- Reversible wiper control
- Wiper stages 1 and 2
- Rain sensor operation
- Single wipe
- Alternating park positions (APS)
- Windshield washer system (SWA)
- Wet-arm heater (NAH)
- Headlight cleaning system (SRA)
- Snow mode
- Blocking protection
- Sluggish mode
- Service position
- Washer jet cleaning function
- Check Control messages
- Diagnosis

## Wiper Position

Depending on wiper functionality, the wiper moves into various positions on the windshield:

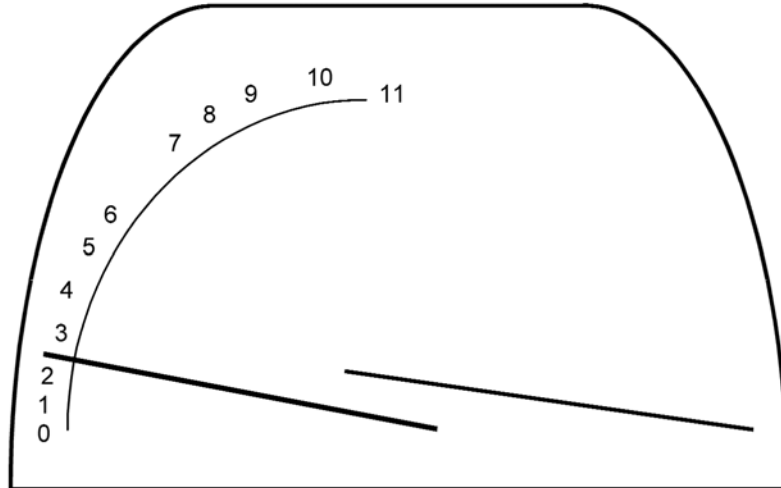

Index	Explanation	Index	Explanation
0	Lowest possible position	6	Blocking limit, minimum range for down stroke
1	Assembly position	7	Rain/Light sensor, up stroke limit
2	Park position, moving down	8	Rain/Light sensor, down stroke limit
3	Park position, moving up	9	Service position (wiper arms)
4	Lower reversing position for intermittent wipe	10	Blocking limit, minimum range for upstroke
5	Lower reversing position for stage 1 and 2	11	Upper reversing position

## Regulated Wiper Speed

Wiping frequency and wiper arm speed are regulated according to:

- Wiper stage
- Vehicle speed
- Wiping direction

As a result, system voltage is compensated. The characteristics files for wiper speed are stored in the EEPROM.

## Reverse Wiper Control

Activation of the wiper system by reversing of the wiper motor is implemented in the wiper electronics. This reduces the space required by the wiper linkage.

Overrun of the wiper positions is prevented, as the wiper motor is braked in the end position. By changing the polarity of the supply, the wiper motor stops suddenly without running on.

---

## **Wiper Stages 1 and 2**

The wiper is energized via a signal generated by the wiper switch in stage 1 or stage 2. Once switched on, the wiper moves immediately if terminal R is "on".

The wiper moves into the reversing positions at reduced speed (PWM) to ensure that the wiper arms move smoothly.

### **Note: The wiper is switched off when terminal R is "off"**

When terminal R is "off", the wiper stops immediately, (the wiper can stop in the middle of the windshield).

For safety reasons, the wiper arms are not moved until the windshield wiper switch is actuated again.

## **Rain Sensor Operation**

The Rain/Light Sensor controls the interval duration and the wiper speed after pushing the contact button on the side of the wiper lever.

The aim of rain sensor operation is to relieve the strain on the driver by automatically controlling the wipers. Even in very different rain situations, manual intervention is no longer necessary.

The wiper motor speed is controlled steplessly by means of a PWM signal. The Rain/Light Sensor sets the wiper motor speed depending on the degree of rain/snow on the windshield.

A defined minimum speed is maintained in order to avoid skipping of the wiper blades. This minimum speed is 35 wipe strokes per minute.

Wiper speed control is performed in addition to the interval duration. As of a certain rain intensity, adjustments are made to the wiper speed control only.

After every wiping cycle, the wiper motor moves into the reversing position. If the wiper motor is not triggered again by the Rain/Light Sensor within a period of 3 minutes, the wiper motor moves into the park position.

Sensitivity can be adjusted manually in 4 stages with the thumbwheel on the wiper switch.

After KL R is switched off, if the rain sensor is required the button must be pressed again.

---

## Single Wipe

If the wiper switch is pushed down in the direction of single wipe mode, wiper stage 1 is activated as long the switch is held.

After releasing the single wipe position, this wiping motion is terminated when the wiper reaches the alternating park position.

The reversing position during the single wipe operation corresponds to the reversing position in stage 1.

The single wipe function can also be activated during rain sensor operation.

## Alternating Park Position (APS)

The wiper control recognizes two park positions outside the field of view of the driver. In the park position, the wiper control alternates between the following park positions every 4 days:

- Lower park position
- Upper park position

This feature prevents permanent deformation of the wiper blade rubber. The wiper module decides whether the upper or the lower park position has been selected on the basis of the wiper-arm time in a certain park position. For this purpose, a K-CAN S message (year/month/day) from the Kombi is evaluated. This ensures that the wipers are parked as evenly as possible (50 : 50).

The wiper are moved to the alternating park positions under the following conditions:

- Terminal R "off" and wiper off (wiper is in park position).

---

## Windshield Washer System (SWA)

A washing program is activated depending on the wiper position, direction of movement and the actuation time of the windshield washer switch. During each upward stroke of the wiper arm, the windshield is wet using 2 nozzle outlets in both wiper arms in front of the wiper blade.



Washing program:

- Washer contact is operated.
- Washer pump is activated.
- The upwards stroke of the wiper is executed with a delay of 500 ms. This delay ensures that the wiper blade is pre-wet.
- Shortly before reaching the upper reversing position, the washer pump is deactivated in order to reduce soiling of the side windows.
- The windshield is not wet during the downward stroke (the downward stroke dries the windshield).
- After releasing the washer contact, 3 final wiping cycles are executed (three complete upward/downward strokes).

If the rain sensor is activated, a final wipe cycle (three continuous wiping operations) is executed. The control unit then switches back to rain sensor operation.

An intensive cleaning system such as in the E38 is no longer used. The reasons for this are:

- Customer servicing costs
- Environmental concerns



---

## **Wet-Arm Heater (NAH)**

For the first time in a BMW, a wet-arm heater is used for the E65. On the E65, there are no conventional heated washer jets in the hood.

In the wet-arm heater, the hoses for the washer fluid are in the wiper arm. This part of the washer fluid hose is electrically heated. The outlets of the windshield washer system are integrated in the wiper arm.

The washer fluid hose is heated using a PWM signal to control the current flow:

- With terminal R "on"
- Depending on the ambient temperature
- Depending on the battery voltage: with power reduction (battery load with priority 5, 6 via CAN) the power supply to the wet arms is decreased in half.

This can double defrosting times compared with normal times. The wet-arm heater is switched off while terminal 50 is "on".

## **Headlight Cleaning System (SRA)**

The headlight washing system is available as of the "parking light on" signal being received by the WIM from the LM.

A headlight wash has 2 spraying cycles.

A headlight wash is activated automatically:

- When the ignition and the light are "on", a headlight wash is always activated the first time the windshield washer system is operated.
- After the first operation, every 5th time a windshield washing operation is activated.

Following a cycle, no further cycles can be activated within an inhibit period of 5 minutes.

The timed arrest and the SRA counter are reset by terminal R "off".

If the control unit identifies the need to refill the water tank, a headlight wash is only activated with every eighth wash requested. This requirement is identified by the Instrument Cluster (message via K-CAN S).

---

## Snow Mode

When the windshield is covered with snow, the wiping action produces wedges of snow at the upper and lower limits of the wipers. These wedges of snow can sometimes block the wipers.

To avoid blocking protection, the wiping area is reduced slightly. The wiper area is reduced within the limits of visual safety.

The wiper system enters snow mode when an increased load is detected in the lower or upper area of the windshield. This prevents the wiper from overheating and cutting out when snow wedges at the edge of the wiping range make it extremely difficult for the wipers to move.

Snow mode is identified based on the following parameters:

- Wiper arm speed
- PWM voltage (increase in current needed to maintain current wiper speed)

In snow mode, the wiper control continuously tries to increase the wiper range until normal operation is restored.

## Blocking Protection

If the wiper cannot wipe the regulation required windshield area on account of difficulty to move, the blocking protection trips under the following conditions:

- If blocking is detected, the wiper is initially switched off for 1 second. Following this, up to 3 restart attempts are performed.
- If the wipers are still blocked, the wiper arms are stopped in the lowest possible position.
- The washer pump is inhibited.
- The pump of the headlight cleaning system is inhibited.

**For safety reasons, wiping is not automatically restarted after the blocking protection has tripped in order to protect the customer from injury if he/she tries to free the wiper while it is still switched on!**

The blocking protection is not cancelled until the wiper is switched on again.

---

## Sluggish Mode

If the wiper control detects an increase in load across the central portion of the windshield (based on the parameters wiper arm speed and PWM voltage), the wiper goes to sluggish mode.

In sluggish mode, wiper speed is decreased and the wiper setting is reduced to max. stage 1. The wiper remains functional even when it is extremely difficult to move.

The wiper does not overheat or is not switched off even if it is extremely difficult to move due to mechanical jamming or application of force.

## Workshop Hints

### Service Position

To replace the wiper blades, the wiper arms must be moved to the service position:

- Switch off terminal R by pressing the start/stop button.
- Lift the wiper stalk past the detent (position 2) within a minute and hold it for 3 seconds.

The wipers move to the service position and stop in this position (the wipers are positioned almost vertically on the windshield).

The wipers do not return to the park position until terminal R is "on" and a wiper stage is switched.

## Washer Jet Cleaning Function

The washer jet cleaning function is used to clean the washer jets, check the quality of the spray jets and to monitor the wiper arm or washer jet setting in relation to the windshield after assembly work and servicing.

The washer jet cleaning function is activated when:

- The wiper arms are in the park position.
- Terminal R is "off".
- The washer pump contact is actuated continuously for at least 3 seconds within 60 seconds (activation period).



The washer jet cleaning function can be activated several times within the 60 s activation period. Here is how the washer jet cleaning function works:

- The washer pump of the windshield washer system (SWA) is activated as long as the windshield wiper switch (SWS) is actuated.
- Pulsed at full capacity for 30 seconds.
- No wiper arm motion.

## Check Control Messages

The functions of the wiper system are monitored by the instrument-cluster control unit as from terminal R "on".

In the event of a malfunction, the following Check Control messages are displayed in the instrument cluster:

Check Control Message displayed in Kombi	Message displayed in Control Display	Cause
Windshield wiper fault! 	"Windshield wiper fault!" Temporary windshield wiper fault. Wipers may remain in continuous operation. Please contact nearest BMW center.	Faulty communication to WIM module or WIM malfunction.
Refill Washer fluid 		Washer fluid reservoir nearly empty

---

The wiper module does not generate the Check Control message "refill washer fluid". The instrument cluster is responsible for monitoring the washer fluid level.

## **Diagnosis**

The wiper module has a non-volatile defective code memory. The wiper module and interface signals are checked for plausibility. If a fault occurs, the following fault messages can be stored:

- Washer pump or cable short circuit or open circuit or reservoir empty
- SRA (headlight wash system) pump or open circuit in cable or short circuit to ground
- Wet-arm heater or open circuit in cable or short circuit to ground
- Wiper sluggish
- Fault Hall sensor 1 armature
- Fault Hall sensor 2 armature
- Fault Hall sensor zero position
- Encoding error
- Internal control unit fault
- CAN fault

The following environmental conditions are stored in addition to the type of fault:

- Frequency
- Ambient temperature
- Battery voltage
- Mileage or km

---

## Default Values

<b>Faulty or missing variable</b>	<b>Default value</b>
Windshield wiper switch	Wiper stage 1 "on"
Rain/driving light sensor	Intermittent control
Vehicle speed	60 km/h
Terminal R and terminal 50	Terminal R "on"/terminal 50 "off"
Ambient temperature	0°C
Parking light	Parking light "on"
Wiper fluid level	Reservoir almost empty
Date (year/month/day)	Last valid date
Battery load reduction	No reduction
Battery voltage	13.6 V

### **Assembly position for the replacement of the wiper drive unit**

To simplify removal and installation of the wiper drive, move the wiper motor into the assembly position.

In the Diagnosis Program , select "Assembly mode" under "Service Functions".  
The wiper then moves into the zero position.



## Classroom Exercise - Review Questions

1. How does the wiper module detect the “park” position of the windshield wipers?

---

---

---

---

2. How does the wiper drive receive the driver requests for wiper operation? Describe the component and signal path.

---

---

---

---

3. Are the Washer nozzles of the E65 adjustable? How are they heated?

---

---

---

---

4. What makes it possible for the E65 windshield wiper system to have variable upper and lower wiper positions based on detected conditions (e.g. snow, blocking etc.).

---

---

---

---

5. What is the procedure required to put the wipers into the service mode? Is there any procedure that must be followed before removing and replacing the wiper drive unit?

---

---

---

---

---